

IoT based control of electrical appliances with enabled fault detection system

Done by: Wedad Salim Hamed AL-Hashimi

ABSTRACT

The large companies and manufactories are facing problems related to electrical network especially the distribution board. To identify the faults in current distributed generation has made traditional distribution protection schemes mostly ineffective. The employees can't analysis and knowledge the reasons of fault. also, due to overload and short circuit the main breaker of DB off, so it takes time to know where the fault is.

To overcome the problem, we will design an IOT distribution board which will help to identify and show the values of current in each breaker. The DB will be more technology and smart.the Arduino interface with IoT system and distribution board. when the fault occurs in load the CS will sense and disconnect the load so, the ARDUINO will read status of the current and identify the concern breaker. The LCD will show the rating of each breaker and which breaker increase, decrease and it will show the total current. by this information the employees will know the reasons for fault.

In this project we will use many components like Arduino to compare information and send, relay driver to operate the loads, load like appliances, current sener to sense the current, LCD display to show the data and finally we use Iot. The method will be like that Connect the relay driver to the Arduino, and the Arduino will transmit signals to the relay, causing the load to activate. The current sener will then sense the amount of current flowing through the loads and provide the value and data to the Arduino. The Arduino will compare the values and determine the status of the loads, after which it will communicate all data and the type of faults that have happened to the LCD, as well as to the Wi-Fi module to send information to the IoT.

To be more flexible and fix the problem easier and in short time will share all these information to the phone by wifi module. the DHT is used to sense the temperature of DB , when it is high, will manage and show in LCD. by this task the working will be easily and faster to fix the faults in electrical network.

TABLE OF CONTENTS

Approval Sheet	ii
Acknowledgement	iii
Abstract.....	iv
Table of Contents.....	v
List of Figures.....	vii
CHAPTER 1: INTRODUCTION	1
1.1 Problem Statement	1
1.2 Motivation	1
1.3 Objectives	1
1.3.1 General Objective.....	1
1.3.2 Specific objectives	1
1.4 Scope and Limitations	1
CHAPTER 2: LITERATURE REVIEW AND THEORITICAL BACKGROUND... 2	
2.1 Background of study and survey of Existing Solutions	2
2.2 Literature survey.....	3
2.3 Comparative Study	4
2.4 Highlights of the Proposed Solution	8
2.5 Theoretical Background	8
2.6 IoT	8
2.6.1 Main Components used in project	8
2.6.1 Arduino Uno	8
2.6.2 SPDT RELAY.....	9
2.6.3 LCD display	10
2.6.4 ULN2803:	10
2.6.5 Current Senser	11
2.6.6 Wi-Fi Module.....	12
2.6.7 DHT11	12
CHAPTER 3: MODELING AND SYSTEM DESIGN METHODOLOGY..... 13	
3.1 System Modeling and Operation.....	13
3.1.1 Block Circuit Diagram	13

3.1.2	Block Description.....	14
3.1.3	Functional Circuit Diagram.....	14
3.2	ThingSpeak IoT.....	15
CHAPTER 4: RESULT ANALYSIS AND DISCUSSION ON FINDING		16
4.1	Presentation of Developed Solution.....	16
4.2	Discussion on Findings:	16
4.3	Result Hardware	17
4.4	Results from Thingspeak.....	18
CHAPTER 5: CONCLUSIONS & FUTURE SCOPE		22
5.1	Conclusions	22
5.2	Future Scope of the Project	22
REFERENCES.....		23
APPENDIX A: Gantt Chart (2021 – 2022).....		25
APPENDIX B: LIST OF COMPONENTS		26
APPENDIX D: Project photos		27

LIST OF FIGURES

Figure 2.1 Schematic Diagram of Arduino	9
Figure 2.2 SPDT Relay	10
Figure 2.3 LCD display.....	10
Figure 2.4 Relay Driver.....	11
Figure 2.5 Current Senser	11
Figure 2.6 Wi-Fi module.....	12
Figure 2.7 DHT11	12
Figure 3.1 Block Diagram.....	13
Figure 3.2 Circuit Diagram.....	14
Figure 4.1 Normal circuit.....	17
Figure 4.2 when circuit has short circuit.....	17
Figure 4.3 when circuit has overload circuit.....	18
Figure 4.4 Temperature graph under normal circuit	18
Figure 4.5 load 1 graph under normal circuit.....	19
Figure 4.6 load2 graph under normal circuit.....	19
Figure 4.7 load2 graph when occur overload	20
Figure 4.8 load3 under normal circuit.....	20
Figure 4.9 Load3 graph when occur short circuit	21
Figure 4.10 load4 graph under normal circuit.....	21

LIST OF TABLES

Table 2-1 comparative study	4
Table 4-1 Results.....	16
Table 0-1 Grant Chart	25
Table 0-1 list of components.....	26

CHAPTER 1: INTRODUCTION

1.1 Problem Statement

Many manufacturers face problems related to faults in electrical circuits. Also, difficulty identifying the faults. To address this problem, we will develop a way to easily identify the fault. The Arduino will interface with IoT and distribution board, in order to identify the values of current in each load, analyse the faults and control the distribution board.

1.2 Motivation

Electricity companies or regular companies have difficulty determining the electrical fault that occurs suddenly. So, we thought of a way to solve this issue, to make the process easy and accurately identify the fault in a shorter time and without any errors. The idea of the project is simple as follows: make an intelligent distribution board which is controlled by IOT in order to show and transfer the rating of each load to LCD and application with employees. Also, analysis the errors.

1.3 Objectives

They are general and specific objectives aimed at the development of the project.

1.3.1 General Objective

To detect and control the fault that occurs in large companies using IoT and identify it easily with less time.

1.3.2 Specific objectives

1. To facilitate the process of determining faults.
2. To control the load remotely

1.4 Scope and Limitations

The distribution board uses IoT to control and analyse the fault that occurs breakers and lead switch off the electrical. In this project, it will be used to control all breakers, know the type for fault. The advantage of the project is fixing and controlling the loads by IoT. The limitations are when the network is bad and it is difficult to control by IoT and when a series fault occurs in a circuit, the current will be zero, so it is not detected, so the circuit does not work.

CHAPTER 2: LITERATURE REVIEW AND THEORITICAL BACKGROUND

2.1 Background of study and survey of Existing Solutions

A novel smart distribution board employing SSCB as its breaker to interrupt fault currents and an IoT based real-time monitoring of the parameters of each sub-circuit integrated with home automation at the DB level for residential systems that could facilitate the needed infrastructure for smart grids at the residential end. The solid-state breaker works with a bi-directional SCR switch along with a low-cost Arduino micro-controller for intelligent control to interrupt extreme currents faster. Smart Distribution board is integrated with IoT based real-time monitoring of current, power and energy of each of the sub-circuits and the user is intimated of any abnormal operation in the sub-circuits, providing scope for better energy management. Home automation at the distribution board makes it convenient and user-friendly [1].

A technique of implementing Demand Side Management (DSM) program to benefit the utility provider, the customer, the nation and the world by installation of a smart distribution board (Smart DB) at the consumer's point to enable utility company to selectively turn on or off, the appliances connected The Smart DB will consist of electronic actuators connected to the switches of the various circuits to the appliances and controlled by signals transmitted from the utility provider with limited option to the consumer[2].

The development of SDSs and resulting benefits of enhanced system capabilities are discussed, A comprehensive survey is conducted on the state-of-the-art applications of RCSs and smart meters in SDSs. Specifically, a new method, called Temporal Causal Diagram (TCD), is used to incorporate outage notifications from smart meters for enhanced outage management. To fully utilize the fast operation of RCSs, the spanning tree search algorithm is used to develop service restoration strategies. Optimal placement of RCSs and the resulting enhancement of system reliability are discussed. Distribution system resilience with respect to extreme events is presented [3].

A new system design that comprises the use of high-speed sensors such as CT and sockets to make the grid smarter, a novel approach and trial for 3000+ homes in Singapore of achieving a large capacity of demand management by developing a smart distribution board (DB) in each home with

the high speed metering sensors(>6 kHz sampling rate) and non-intrusive load monitoring (NILM) algorithm, that can assist home users to perform the load/appliance profile identification with daily usage patterns and allow targeted load interruption using the smart sockets/plugs provided [4].

A system that will identify or detect any electrical system defects and warn the user in real time. The system also delivers information about the real time power factor, energy consumption, etc, create a Smart Distribution Board with various sensors and a cross-platform application that can alert users to any surges in the electrical system, provide real-time energy consumption, and provide necessary alerts and warnings, as well as a system to detect power factor variation and alert users [5].

Make a Distribution Board(DB)smart byIn corporation an innovative sensor and coupled it with Data analytics. Usage from its individual circuit breakers and derive rich Insights pertaining to energy usage, and occupants'Behavior and habits to provide a simple ,all-in-one And cost-effective management solution [6].

2.2 Literature survey

By searching in various studies related to faults in electrical circuits and identify the faults in a correct and effective way.We found that each study has different method and use different sensor and equipment.

In our project we use Iot to make the determine fault easy.And our method is like that Connect the arduino to the relay driver, and the arduino will send signals to the relay to control the load. The current transformer will then detect the amount of current flowing through the loads and send the value and data to the Arduino. The arduino will compare the values and determine the status of the loads, after which it will transmit the information to the LCD to display all data and type of faults that have happened, as well as to the Wi-Fi module to send the information to the IoT.We use CS work like sensor.

2.3 Comparative Study

Table 2-1 comparative study

Title of the paper	objective	Method used	Equipment used	sensor	conclusion
Solid-State Circuit Breaker based Smart Distribution Board with IoT Integration [1].	a novel smart distribution board employing SSCB as its breaker to interrupt fault currents and an IoT based real-time monitoring of the parameters of each sub-circuit integrated with home automation at the DB level for residential systems that could facilitate the needed infrastructure for smart grids at the residential end.	The solid-state breaker works with a bi-directional SCR switch along with a low-cost Arduino micro-controller for intelligent control to interrupt extreme currents faster. Smart Distribution board is integrated with IoT based real-time monitoring of current, power and energy of each of the sub-circuits and the user is intimated of any abnormal operation in the sub-circuits, providing scope for better energy management. Home automation at the distribution board makes it convenient and user-friendly	SSCB	Current sensor	The performance of the SSCB was evaluated by simulation using MATLAB Simulink. The results clearly indicate that at fault instance, the SSCB is quickly able to interrupt the fast rising currents making a suitable choice for the DB.

<p>SMART DISTRIBUTION BOARD FOR ACTIVE LOAD SHIFTING FOR DEMAND SIDE MANAGEMENT APPLICATIONS [2].</p>	<p>a technique of implementing Demand Side Management (DSM) program to benefit the utility provider, the customer, the nation and the world by installation of a smart distribution board (Smart DB) at the consumer's point to enable utility company to selectively turn on or off</p>	<p>the appliances connected The Smart DB will consist of electronic actuators connected to the switches of the various circuits to the appliances and controlled by signals transmitted from the utility provider with limited option to the consumer</p>	<p>load shedding, selective, active shifting, DSM, smart DB.</p>	<p>No sensor</p>	<p>The consumer can control the power consumption via the internet. There is a possibility of the Smart DB facilitating automatic meter reading for purposes of billing the consumer.</p>
<p>Distribution Systems [3].</p>	<p>the development of SDSs and resulting benefits of enhanced system capabilities are discussed, A comprehensive survey is conducted on the state-of-the-art applications of RCSs and smart meters in SDSs. Specifically, a new method, called</p>	<p>To fully utilize the fast operation of RCSs, the spanning tree search algorithm is used to develop service restoration strategies. Optimal placement of RCSs and the resulting enhancement of system reliability are discussed. Distribution system resilience with respect to extreme events is presented</p>	<p>feeder restoration; outage management; remote control capability; smart distribution system (SDSs); smart meter.</p>	<p>No sensor</p>	<p>For enhanced outage management, TCD incorporates outage reports from smart meters to accurately identify the fault location.</p>

	Temporal Causal Diagram (TCD), is used to incorporate outage notifications from smart meters for enhanced outage management.				
Smart Distribution Boards (Smart DB), Non-Intrusive Load Monitoring (NILM) for Load Device Appliance Signature Identification and Smart Sockets for Grid Demand Management[4].	a new system design that comprises the use of high-speed sensors such as CT and sockets to make the grid smarter	a novel approach and trial for 3000+ homes in Singapore of achieving a large capacity of demand management by developing a smart distribution board (DB) in each home with the high speed metering sensors(>6 kHz sampling rate) and non-intrusive load monitoring (NILM) algorithm, that can assist home users to perform the load/appliance profile identification with daily usage patterns and allow targeted load interruption using the smart sockets/plugs provided	Home-ESS; smart distribution board; smart sockets; grid stability	Speed sensor	More effective than any existing load shedding schemes to balance the grid, while minimizing inconveniences by taking their load priorities into consideration.

Distribution Board and Smart Plug [5].	a system that will identify or detect any electrical system defects and warn the user in real time	The system also delivers information about the real time power factor, energy consumption, etc, create a Smart Distribution Board with various sensors and a cross-platform application that can alert users to any surges in the electrical system, provide real-time energy consumption, and provide necessary alerts and warnings, as well as a system to detect power factor variation and alert users	Energy consumption, current sensor, voltagesensor, raspberry pi, smart plug	Current , voltage sensor	The app notifies users when severe weather conditions such as lightning thunderstorms, and other events occur, which is one of the leading causes of electrical appliance damage.
Smart Distribution Board. [6]	Make a Distribution Board(DB)smart byIn corporation an innovative sensor and coupled it with Data analytics	Usage from its individual circuit breakers and derive rich Insights pertaining to energy usage, and occupants'Behavior and habits to provide a simple ,all-in-one And cost-effective management solution	corporation an innovative sensor	innovative sensor	The performance of the SSCB was evaluated by simulation using MATLAB Simulink. The results clearly indicate that at fault instance, the SSCB is quickly able to interrupt the fast rising currents

					making a suitable choice for the DB.
--	--	--	--	--	--------------------------------------

2.4 Highlights of the Proposed Solution

- Correctly identifying the fault by using Iot.
- Iot can work of employees and customers easier by check the fault Far from the distribution meter.
- This system is more compact and reliable as compared to the manual system.

2.5 Theoretical Background

Through our scientific and theoretical knowledge in the department we are studying, we know that by using Arduino UNO and internet of things we can solve most problems in any where nd every time, in an easier way.

2.6 IoT

The term "Internet of Things" (IoT) refers to actual physical items (or collections of such objects) that have sensors, computing power, software, and other technologies and can connect to and exchange data with other systems and devices over the Internet or other communications networks. Consumer-focused IoT devices, such as linked cars, smart homes, wearables, connected health, and appliances with remote monitoring capabilities, make up an increasing share of the market. IoT tracking offers an effective way to track and monitor anything, including shipping containers, stolen products, and vehicle fleets. Even environmental changes can be detected by specific instruments. IoT trackers can significantly increase business productivity across a wide range of sectors.

2.6.1 Main Components used in project

The main components used in our project are ARDUINO UNO, LCD DISPLAY,RELAY,CURRENT SENSER , ULN2803, Wi-Fi MODULE, DHT11.

2.6.1 Arduino Uno

The Arduino UNO is a microcontroller that makes use of the ATmega328 as a controller. There are 14 digital I/O pins, 6 analog input pins, a USB assembly, a Power barrel jack, an ICSP heading, and a reorder button on this board. In Arduino programming, the 14 digital (I/O) pins can be rummaged-

sale as I/O pins using pin Mode, digital read, and digital write. Both pins function at 5V and can supply or receive a maximum of 40mA current. They also contain a 20-50 K Ohm inner pull-up resistor that is deactivated by avoidance. There are 6 analog input pins in addition to the 14 digital pins, each of which has a resolution of 10 bits, or 1024 possible values .They measure from 0 to 5 volts, but by using the AREF pin with the analog Reference () function, this limit can be raised. Shown in figure 2.1 below.[7].

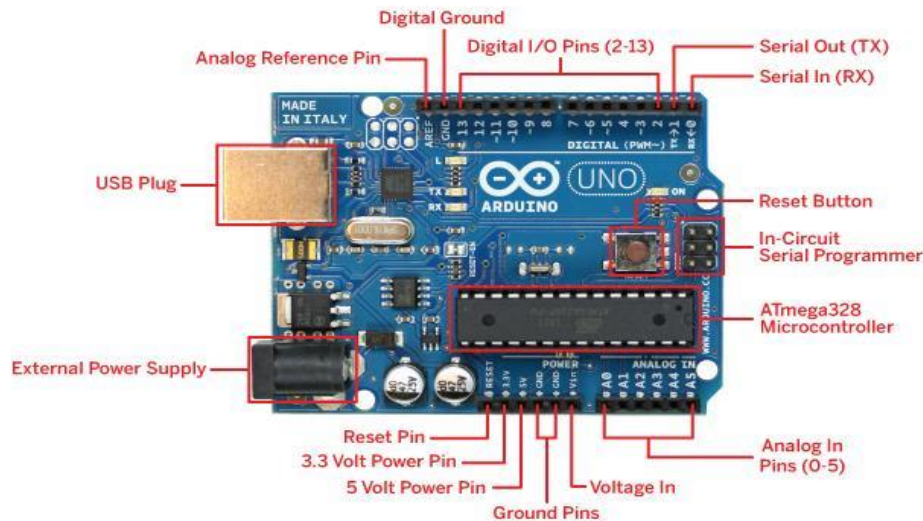

Figure 2.1 Schematic Diagram of Arduino ¹

2.6.2 SPDT RELAY

Relays are the switches which aim at closing and opening the circuits electronically as well as electromechanically. Relays are normally used in the control panels, manufacturing and building automation to control the power along with switching the smaller current values in a control circuit. However, the supply of amplifying effect can help control the large amperes and voltages because if low voltage is applied to the relay coil, a large voltage can be switched by the contacts .In our project We control the relay from microcontroller, so we connect the load to relay. If the load should switch on, microcontroller send signal to the relay will switch on the load.Show in figher 2.2[8].

¹https://www.google.com/search?q=arduino+uno&source=lnms&tbm=isch&sa=X&ved=2ahUKEwiyxOaYwMzmAhWRPFAKHw01D60Q_AUoAXoECBIQAw&biw=1366&bih=657#imgrc=XWnM7h5aC3-FoM

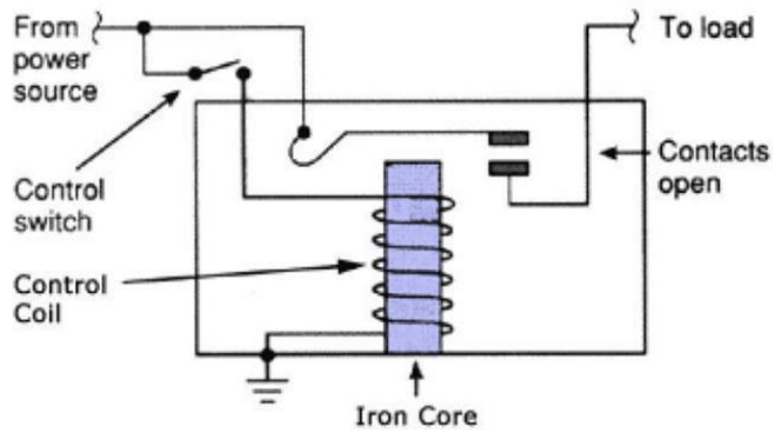

Figure 2.2 SPDT Relay ²

2.6.3 LCD display

LCD display is very important part in digital world because that is using liquid crystals to produce image. It used to provide the data or number that help people to read and witch. In our project we used the LDC for showing the load state and value of current crosses the load. shown in figure 2.3 [9].



Figure 2.3 LCD display³

2.6.4 ULN2803:

The ULN2803 is a relay driver. The ULN2803 is a relay driver with a Darlington transistor array that can operate at high voltages and currents.

² <https://www.electgo.com/control-relay/>

³ <https://www.google.com/imgres?imgurl>

shown in figure 2.4[10].

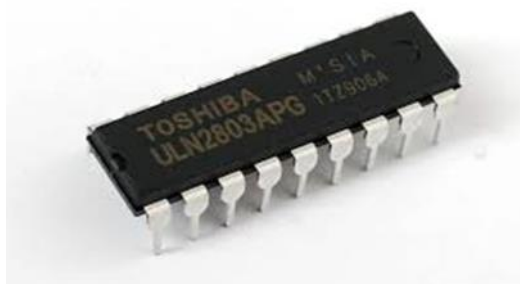

Figure 2.4 Relay Driver⁴

2.6.5 Current Sensor

device that detects current and turns it into an output voltage that is simple to measure and proportional to the current through the measured path. There are many different types of sensors, and each one is appropriate for a particular current range and environmental circumstance. The current sensor is a device that detects and converts current to get an output voltage, which is directly proportional to the current in the designed path. When current is passing through the circuit, a voltage drops across the path where the current is flowing. Also, a magnetic field is generated near the current-carrying conductor. These above phenomena are used in the current sensor design technique. shown in figure 2.6[12].

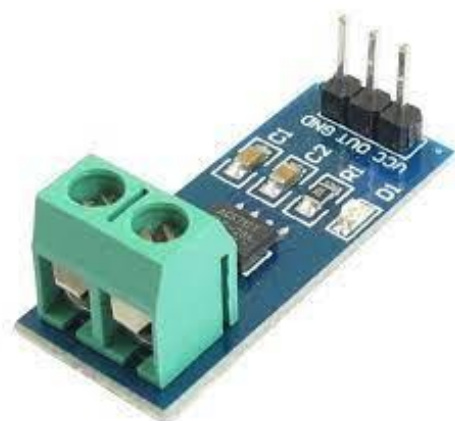

Figure 2.5 Current Sensor⁵

⁴ <https://geeksville.com/product/8-channel-driver-uln2803/>

⁵ <https://www.elprocus.com/acs712-current-sensor-working-and-applications/>

2.6.6 Wi-Fi Module

The ESP8266 Wi-Fi Module is a self-contained SOC with an inbuilt TCP/IP protocol stack that can provide access to your Wi-Fi network to any microcontroller. The ESP8266 may run an application or offload all Wi-Fi networking activities to another processor. We use wi-fi in this project to send all information about load and current from Arduino to IOT. shown in figure 2.7[13].

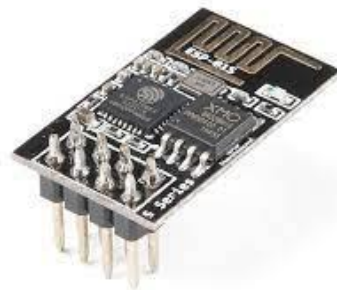

Figure 2.6 Wi-Fi module⁶

2.6.7 DHT11

The DHT11 is a low-cost digital temperature and humidity sensor. This sensor may simply be connected to any microcontroller (Arduino, Raspberry Pi, etc.) to measure humidity and temperature in real time. The DHT11 humidity and temperature sensor comes in two versions: a sensor and a module. The pull-up resistor and a power-on LED distinguish this sensor from the module. A relative humidity sensor is the DHT11. This sensor employs a thermistor and a capacitive humidity sensor to measure the ambient air. We connect it to arduino and If the load have high temperature can it detect directly[14].

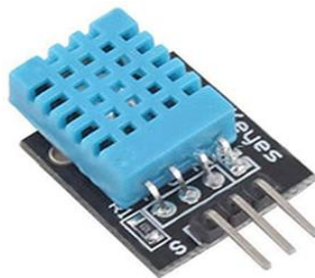

Figure 2.7 DHT11⁷

⁶ <https://www.electronicwings.com/sensors-modules/esp8266-wifi-module>

CHAPTER 3: MODELING AND SYSTEM DESIGN

METHODOLOGY

3.1 System Modeling and Operation

At this part we will include and explain about the working and operation of block and circuit diagram, and from where does the work of each one of it start.

3.1.1 Block Circuit Diagram

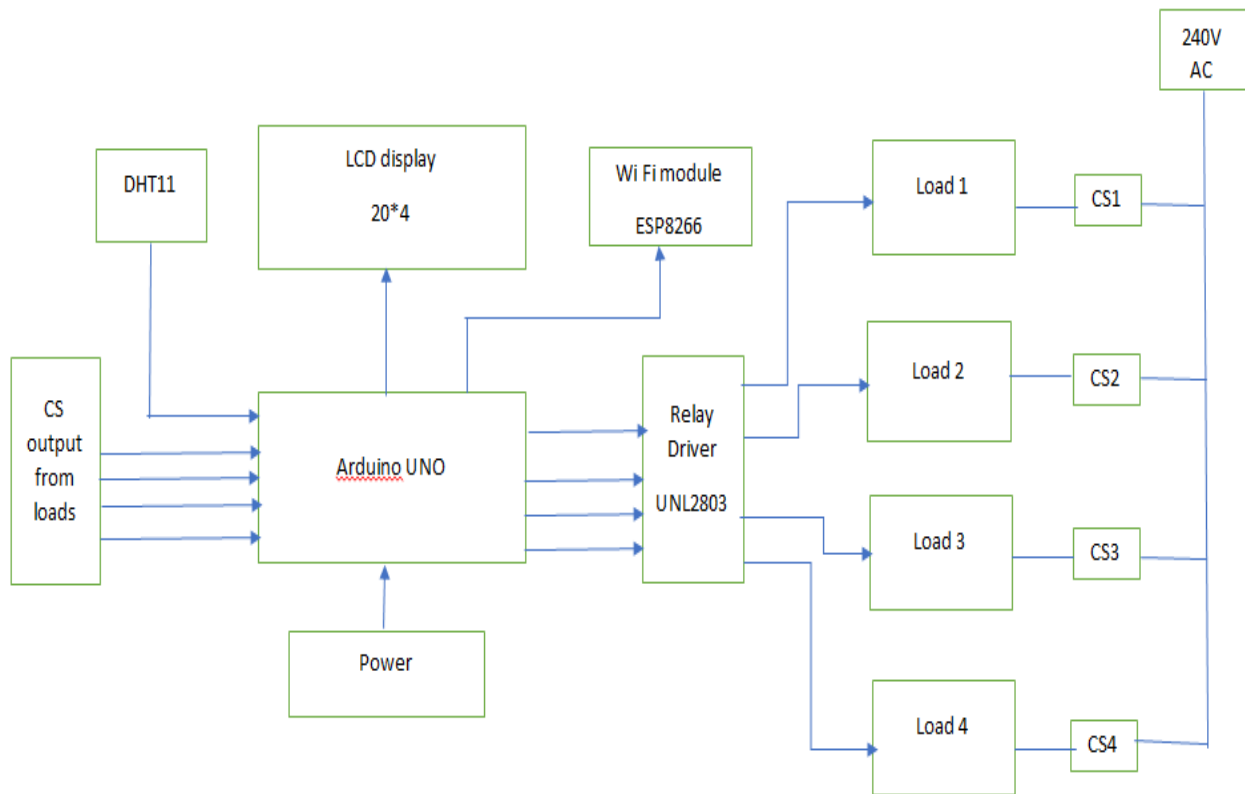

Figure 3.1 Block Diagram

⁷ <https://www.elprocus.com/a-brief-on-dht11-sensor/>

3.1.2 Block Description

Arduino is an interfacing device which connect the relay driver and load. it will send signals to operate relay which control load. After that the current transformer will sense the value of current which is flowing through the loads and send current magnitude and other required data to Arduino. The Arduino will compare the value with the stored data base and identify the status of loads. then the same status will be displayed in LCD to identify all data and type of faults occurred. This arrangement is connected to Wi-Fi module to share the information to IoT which will enable the check the status online. Also, we have DHT11 connected to Arduino that sense the temperature in distribution board to check he reason for temperature rise, These all information will be displayed in LCD as well which show in figure 3.1.

3.1.3 Functional Circuit Diagram

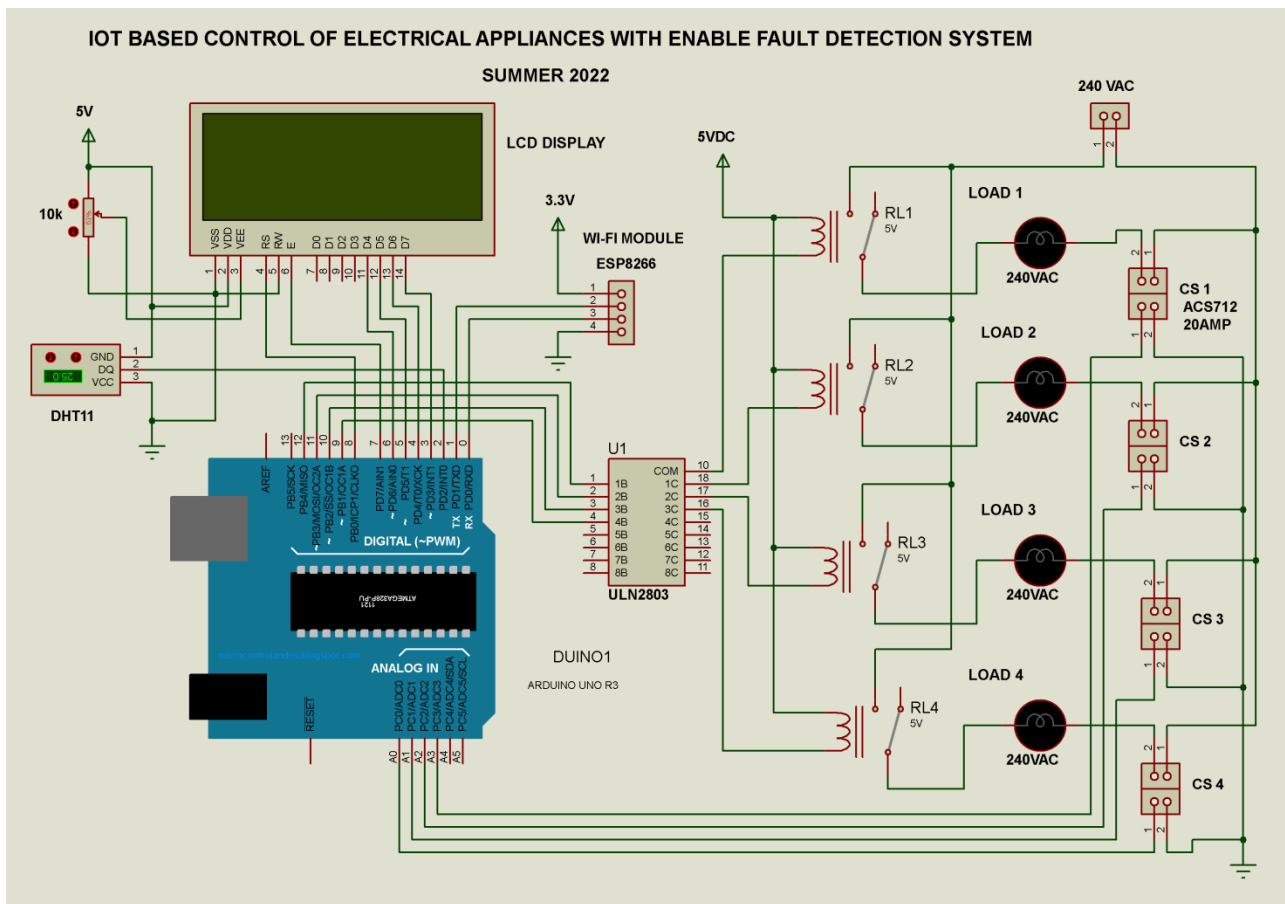

Figure 3.2 Circuit Diagram

The Arduino is controlling the switch to on the relay driver to drive the loads. The current will be observed for each load connected to circuit. Each load has current transformer serially connected to load to sense the status of current magnitude like normal, short circuit current or overload current by comparing database stored in Arduino. Then the four pins in Arduino will work as output from current transfer and send the same information to Arduino and it is ready read. Arduino will compare the value of current magnitude and identify the condition of load status by comparing with available data base. The 6 pins work as output from Arduino to the LCD to show the result and send also to IoT through wi-fi module. The status of each load will also be displayed in LCD display. By interfacing this whole system with IoT to make the distribution board smart. The control of distribution board is enabled for the employee and also to know and show the information about distribution board in online. in case of any fault in any one of the loads the CS will sense the current magnitude, which help employees to identify and analysis the problem each time. It will be more useful for the employee to identify the faults in which load and what type of faults occur in the system. So, fixing the problem and find the solution will also be easily and in short time by this system. Also, we will put temperature senser in the distribution board to sense the temperature to identify the fault and processionary measures. the complete circuit arrangement. shown in Figure 3.2.

3.2 ThingSpeak IoT

ThingSpeak is an IoT analytics platform service:A live data stream can be aggregated, visualized, and analyzed in the cloud. You may send alerts, instantly visualize live data, and send data to ThingSpeak from your devices.

In this IoT project, we'll monitor humidity and temperature as well as current information via the internet using the ThingSpeak server, where we'll display the humidity and temperature data as well as the current value. Data connections between the Arduino, DHT11 Sensor Module, ESP8266 WiFi Module, current sensor, and LCD are used to make it happen. The ambient temperature and humidity are shown on an LCD screen using a Celsius scale thermometer and percentage scale humidity meter. They are also sent to a ThingSpeak server so that they may be monitored in real time from any location in the world.

CHAPTER 4: RESULT ANALYSIS AND DISCUSSION ON FINDING

4.1 Presentation of Developed Solution

The design of an IoT Based Control of electrical appliances with enable fault detection system which help employees to identify the problem that happen in electrical network . The ARDUINO will drive relay driver in order to drive the load. Once the load drive, the CS will sense the current and transfer to ARDUINO . The ARDUNIO will send the current magnitude from load to LCD and WI-fi module to Iot. So, by this step the employee will know and analysis the faults .Also, the temperature will sense the temperature in distribution board to protect the DB and applicants from high temperature .

4.2 Discussion on Findings:

Table 4-1 Results

Condition	The rating	Display
1	I=0-100mA ,normal	Good circuit
2	$i \geq 101$ & $i \leq 150$,overload	Circuit damage
3	$i \geq 151$,short circuit	Circuit damage
4	temperature ≤ 50	Good circuit

- The CS will senses the current in the load ,then send to Arduino .
- The Arduino will read the values from CS and send to LCD .
- The LCD will show the information about loads with loads .
- Also, the information about loads will send to IoT through WI-FI module .
- Temparture senser will sense the temparture of DB avoid damage the applicance because of high temparture .
- Fixing the faults (overload,short circuit) will be easily and in short time by IoT system .

4.3

Result Hardware



Figure 4.1 Normal circuit



Figure 4.2 when circuit has short circuit

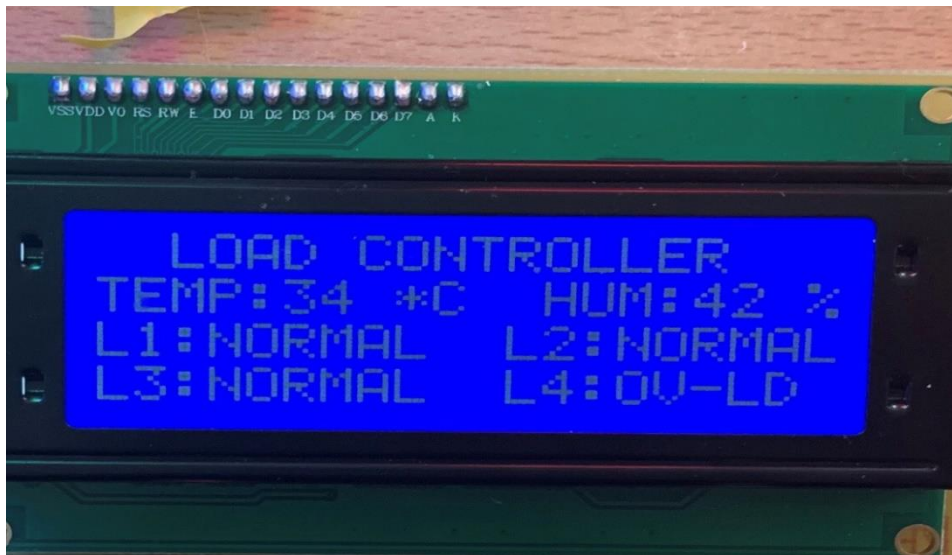

Figure 4.3 when circuit has overload circuit

4.4 Results from Thingspeak

Arduino collects and extracts the data in two parts first is magnitude of current and second is temperature and then send it to 16*4 LCD and ThingSpeak server. ThingSpeak display the data in form of Graph. There is different graph for each load that show the current value at each time of day and keep this data over the course of a month. And also show the temperature value.

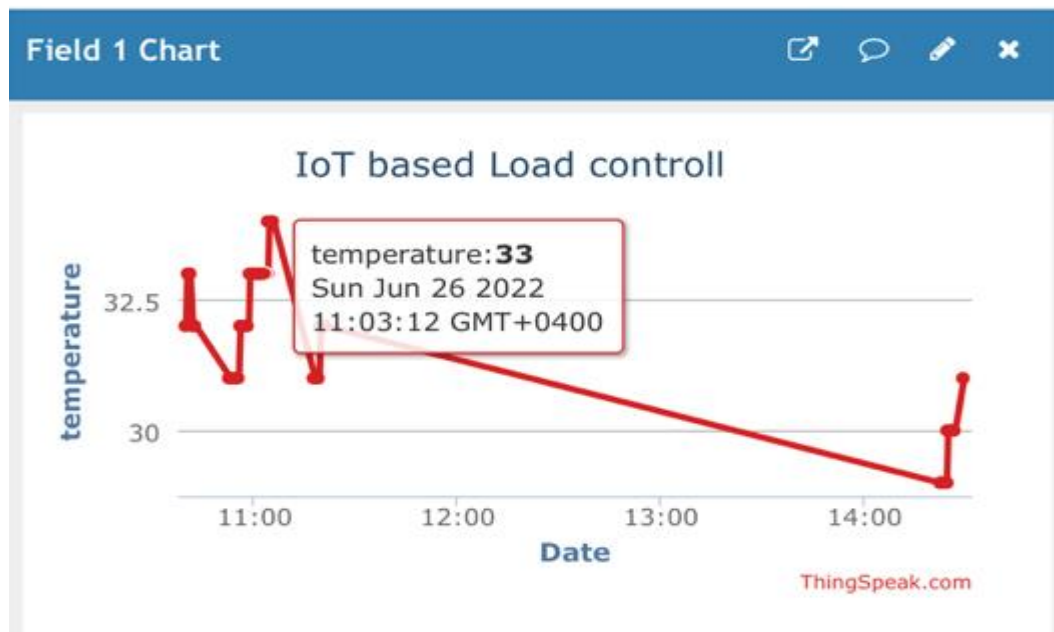

Figure 4.4 Temperature graph under normal circuit

We can check the status of temperature by the graph .It show the value of temperature ,the time and day .The graph show that the temperature is in normal condition is shown in figure 4.1. If there a changing in temperature it will appear in graph .

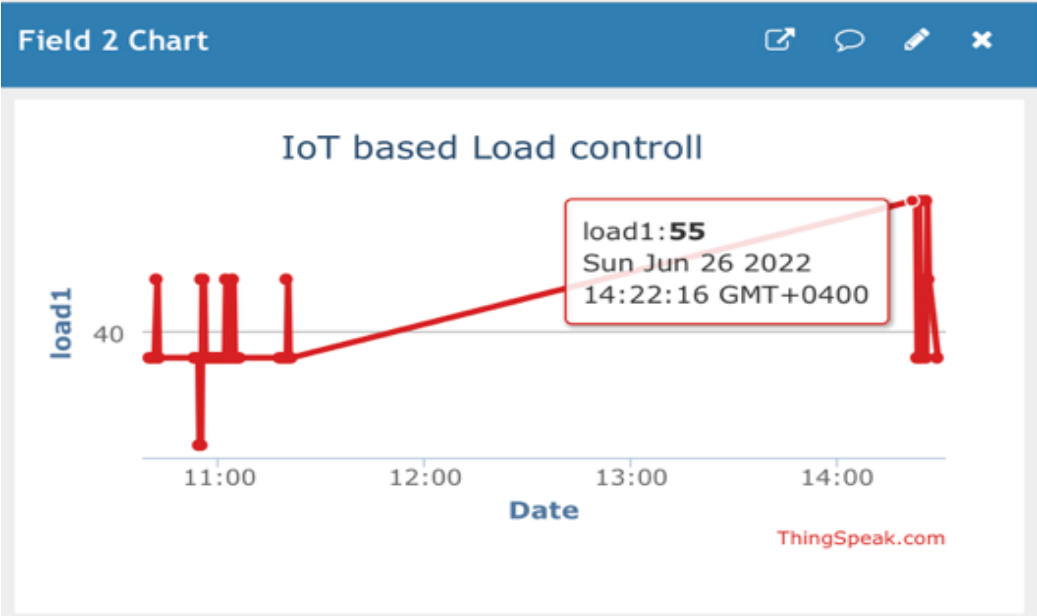

Figure 4.5 load 1 graph under normal circuit

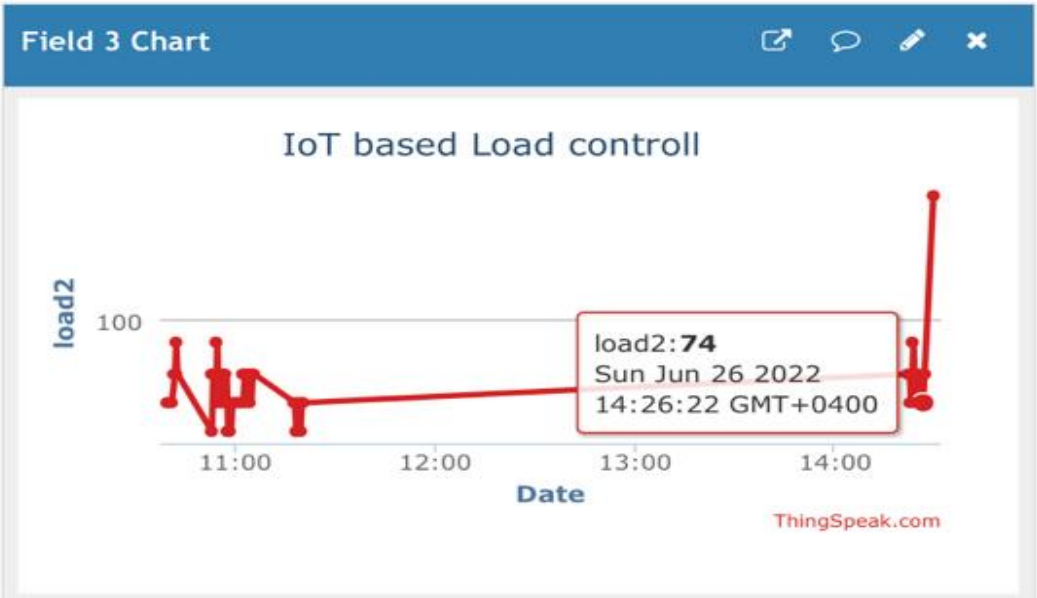

Figure 4.6 load2 graph under normal circuit

In load2 the graph show the magnitude of current which is 74mA in case normal condition which shown in figure 4.3 ,but suddenly it rise to 139Ma because of overload fault that shown in figure 4.4 .

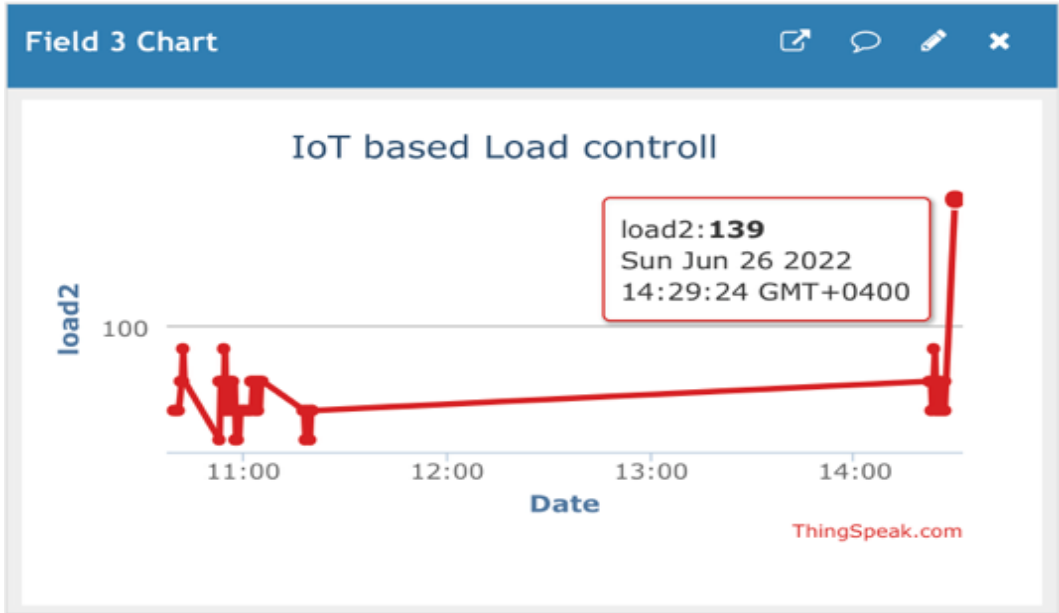

Figure 4.7 load2 graph when occure overload

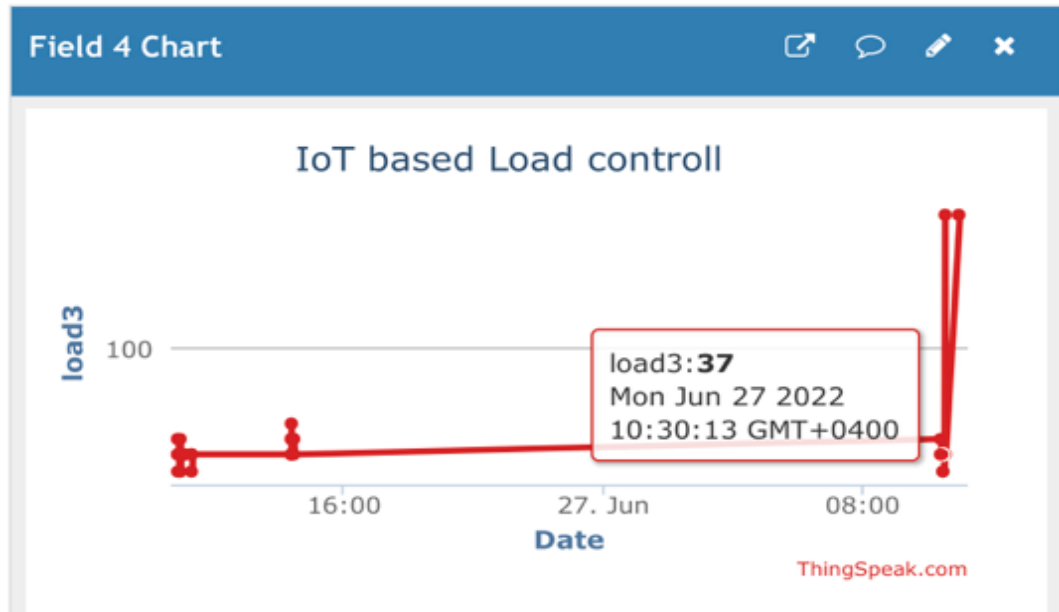

Figure 4.8load3 under normal circuit

In figure 4.5 The graph of load3 show that on Jun 27 at 10:30 has 37 mA, So the circuit is in normal condition. But at 10:59 the value of current is increase to 177 mA, So the circuit will be on short circuit condition, shown in figure 4. 6 .

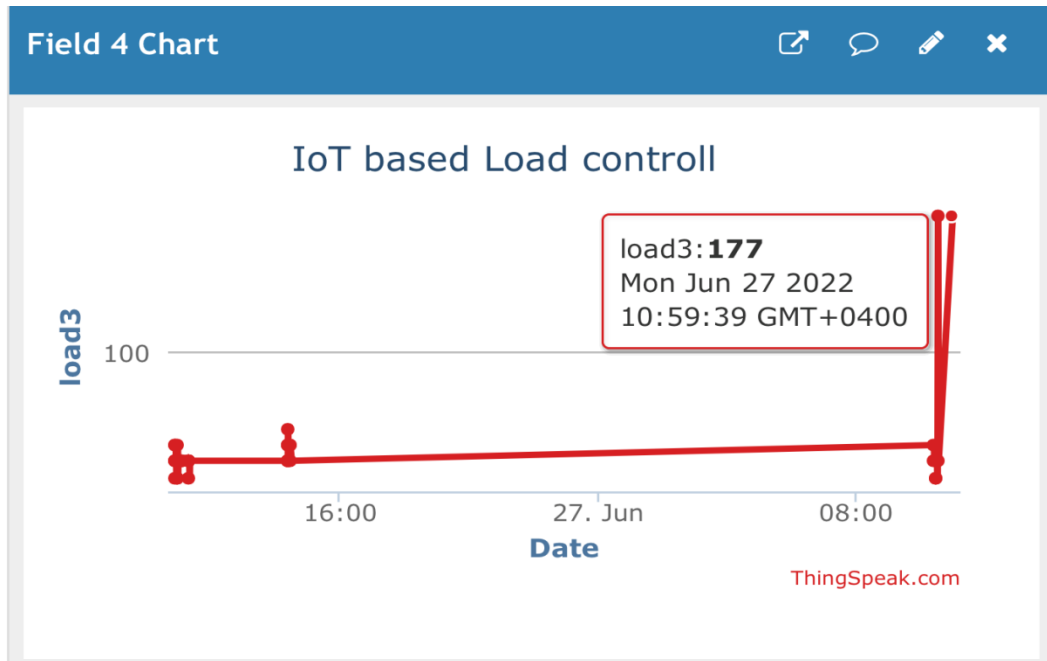

Figure 4.9 Load3 graph when occur short circuit

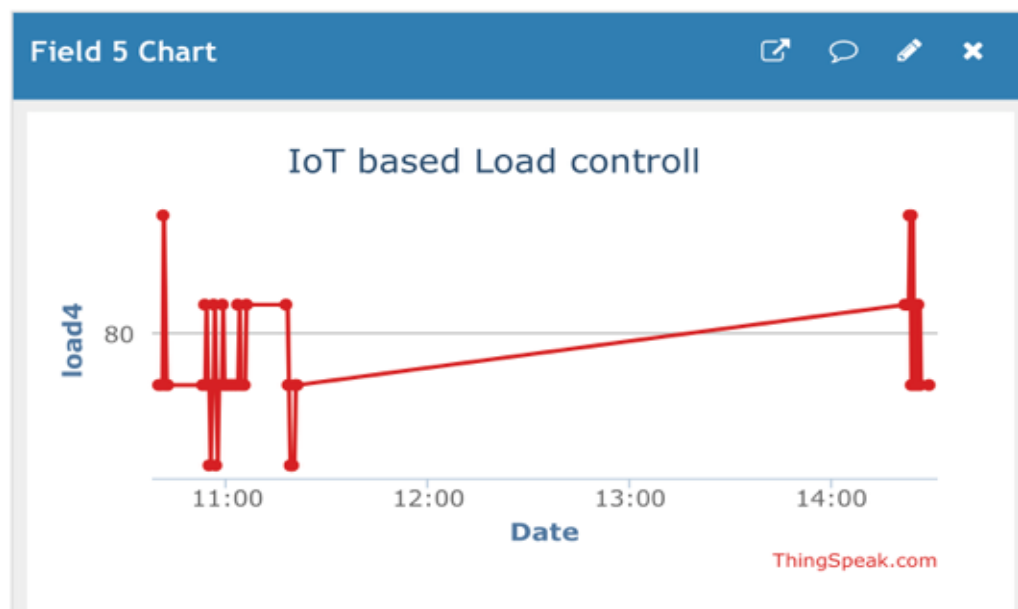

Figure 4.10 load4 graph under normal circuit

CHAPTER 5: CONCLUSIONS & FUTURE SCOPE

5.1 Conclusions

We have designed and developed a system to easily identify the faults by design smart distribution by using IOT. The Arduino will interface with IoT system and distribution board. When the fault occurs in load the CS will sense and disconnect the load. Then the Arduino will read the conditions of the current and also will identify the place of faults in circuit or in which breaker. After that the Arduino will send all this data to two places: to LCD to show the reading of current and the type of faults and to IoT. By this way the employees or the users will know the faults and reason of it. This system may solve the problem of the difficulty of knowing and determining the fault.

5.2 Future Scope of the Project

The challenge is to determine the fault and the value of the current that flows in the circuit easily and in a smart way and in record time using the Internet of things and controlling the turn ON and turn OFF the switch. In the future we will develop the system and use we will use an SMS system to deliver a message to the user when an electrical fault occurs, including where the fault occurred, which switch, current value, and type of fault. Also we can add an application in user phone, Allows him to control all switch remotely.

REFERENCES

- [1] .Akhil Josea, Aneeta M Vargheseb, Femi Elie Jensonc, Philip Jacobd, Anumod D Me, Dennis Thomasf, Solid-State Circuit Breaker based Smart Distribution Board with IoT Integration, Downloaded on March 20,2022 at 06:57:46 UTC from IEEE Xplore. Restrictions apply.
- [2] C C Majani and MTE Kahn, SMART DISTRIBUTION BOARD FOR ACTIVE LOAD SHIFTING FOR DEMAND SIDE MANAGEMENT APPLICATIONS,Cape Peninsula University of Technology in 2007.
- [3] Yazhou Jiang 1, Chen-Ching Liu 1,2 and Yin Xu 1, Smart Distribution Systems, 6 March 2016; Accepted: 11 April 2016; Published: 19 April 2016.
- [4] See Gim Kerk 1 , Naveed UL Hassan 2 and Chau Yuen 1, Smart Distribution Boards (Smart DB), Non-Intrusive Load Monitoring (NILM) for Load Device Appliance Signature Identification and Smart Sockets for Grid Demand Management , 13 April 2020; Accepted: 17 May 2020; Published: 20 May 2020.
- [5] Abinshah Ameen1, Geoji George, Linson S, Sachin , F R Rejish Babu(Asst Prof), Distribution Board and Smart Plug,July 2021.
- [6] Abinshah Ameen1, Geoji George, Linson S, Sachin , F R Rejish Babu(Asst Prof), Distribution Board and Smart Plug,July 2021.
- [7] <https://www.arduino.cc/en/guide/introduction>
- [8] <https://www.electgo.com/control-relay/>
- [9] <https://www.google.com/imgres?imgurl>
- [10] <https://geeksville.com/product/8-channel-driver-uln2803/>
- [11] <https://www.google.com/url?sa=i&url>
- [12] <https://www.elprocus.com/acs712-current-sensor-working-and-applications/>
- [13] <https://www.electronicwings.com/sensors-modules/esp8266-wifi-module>
- [14] <https://www.elprocus.com/a-brief-on-dht11-sensor/>
- [15] <https://www.electgo.com/what-is-a-relay/>
- [16] <https://www.apogeeweb.net/circuitry/uln2803-datasheet-specification-circuit.html>
- [17] <https://www.arduino.cc/en/guide/introduction>
- [18] <https://www.nelson-miller.com/lcd-displays-work>
- [19] <https://www.grainger.com/know-how/equipment-information/kh-what-is-a-current-transformer>

[20] <https://www.sparkfun.com/products/17146>

[21] <https://www.elprocus.com/a-brief-on-dht11-sensor/>

APPENDIX A: Gantt Chart (2021 – 2022)

Table 0-1 Grant Chart

S.No	Activities	Months	
		MAY	JUNE
1	Testing of components on bread board.	■	
2	Design the PCB circuit&print the PCB board.	■	
3	Make connection on PCB and testing.	■	
4	Write the program and upload in microcontroller.	■	■
5	Connect Thingspeak IoT to project.		■

APPENDIX B: LIST OF COMPONENTS

Table 0-1 list of components

Sl. No	Part\Component name	Quantity	Approximate cost
1	Arduino Uno	1	8 Rials
2	Current Sensor	4	8 Rials
3	Relay driver	1	10 Rials
4	Bread board	1	3 Rials
5	Display lcd	1	5 rials
6	Wi-fi	1	6Rials
7	SPDT Relay	1	5 Rials
8	Lamp	4	2 Rials
9	MCB	1	10 Rials
10	Lamp Holden	4	2 Rials
11	PCB	1	5 Rials
12	RMC cabel	1	1 Rials
13	Buzzer	1	1 Rials
Approximate Total cost			66 Rials OMR

APPENDIX D: Project photos

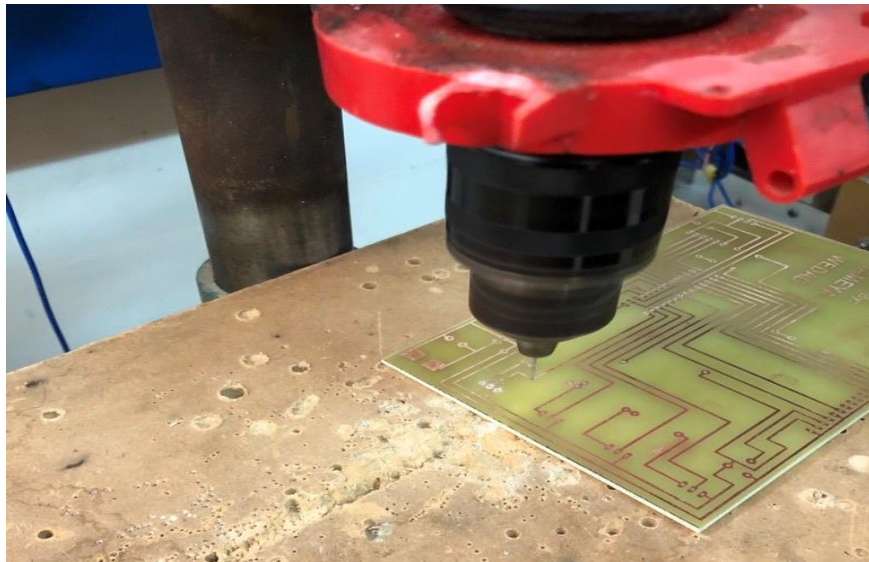
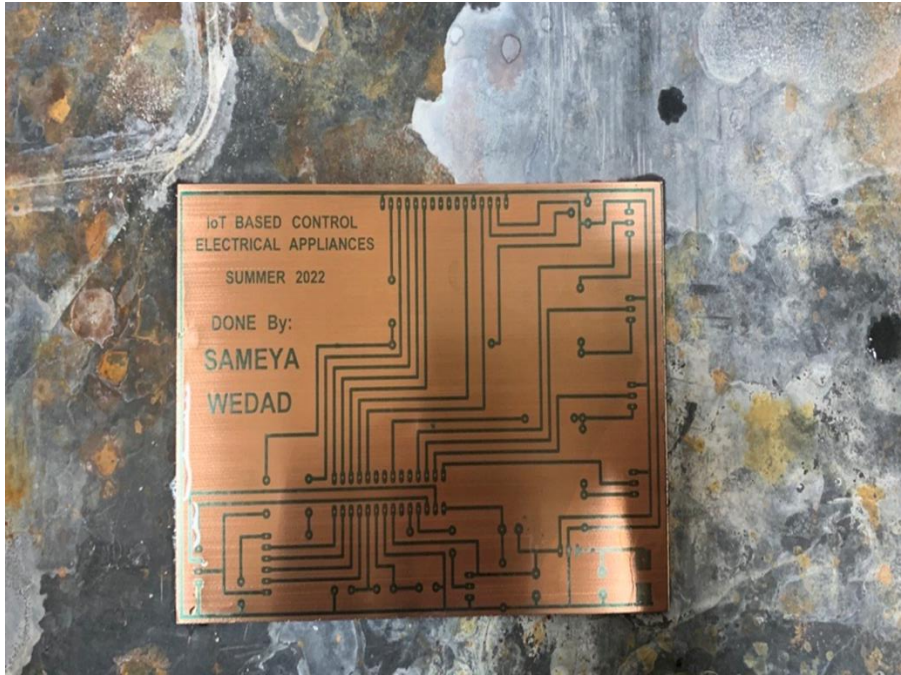

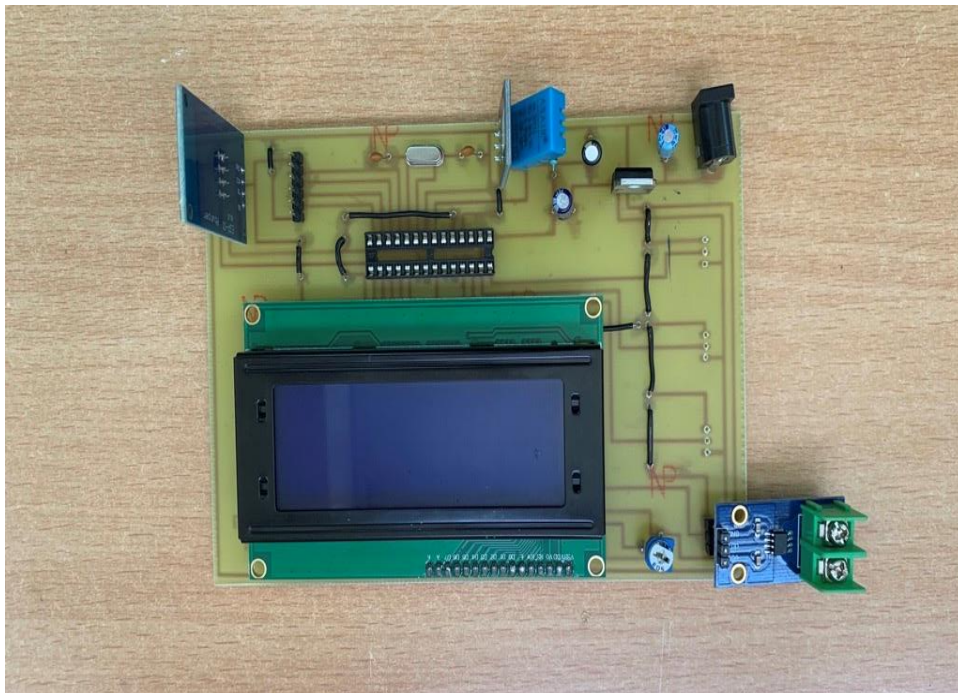
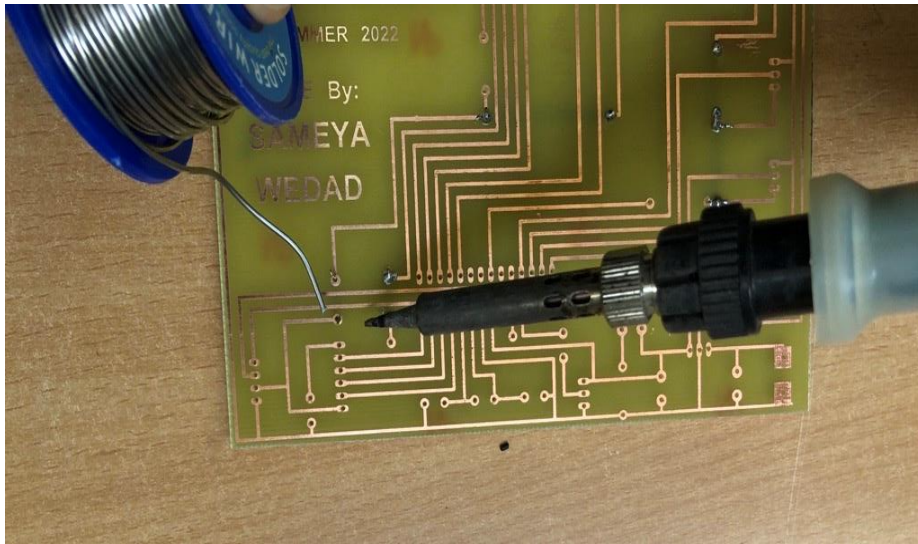

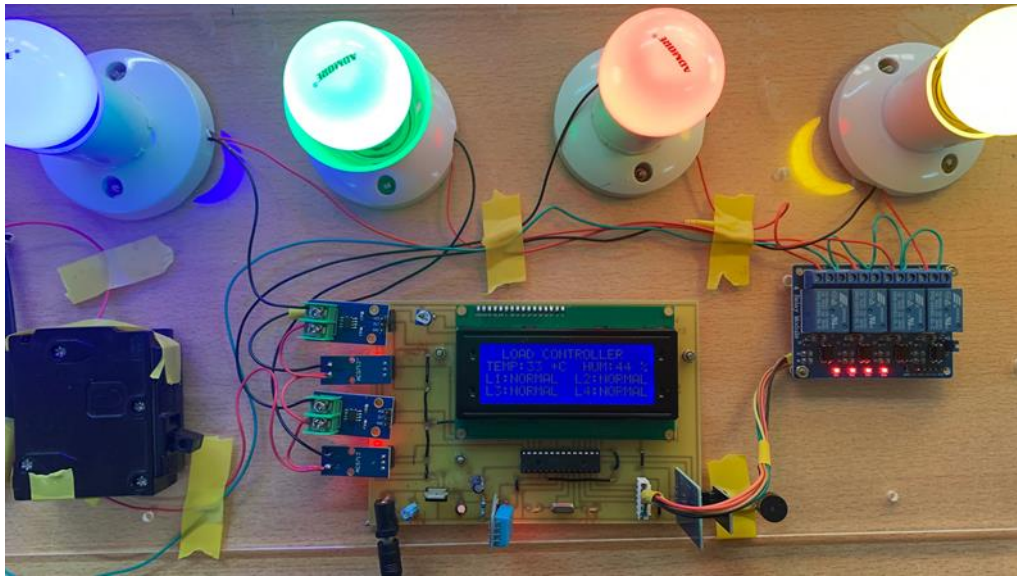

CURRICULUM VITAE

Wedad Al Hashmi

Profile

I have bachelor's degree of power Electrical engineering from University of technology and applied science- Ibra .Also, I strongly believe that my qualification and skills will aid intensively in achieving job career's goals successfully.



ADDRESS

AlKamil wal wafi



PHONE

97556566
9984 0030



EMAIL

Wedadalhashimi31@gmail.com

Activities and Interests

Artificial intelligence, Passion for development and continuing education , Discover new things, search for the problem , find the solution and Quick learning .

KEY SKILLS AND CHARACTERISTICS

- Leader and management skills
- Excellent oral and written communication skills.
- Highly organized
- Very good in English & Arabic
- Skilled problem solver
- Quick learning
- Team player with exceptional thoughtful abilities.

EXPERIENCE AND TRAINING

- 2021 .Training on Mazoon Electricity Company .
- 2022.Training on opamco company .Opamco company has a contract with the O LNG Company and Toco company ,which make me familiar with all the maintenance in the O LNG from the electrical , mechanical and civil sectors and quality management .
- 2023.Traning in omifco company .

EDUCATION

- University of technology and applied science-Ibra .

ACHIVEMENT

- Participation in the Oman Injaz program in student companies .
- participating in DOTNXT program .
- participating in the 13th Engineering students gathering-Art &Engineering that was held in SQU.
- IEEE membership .
- Winning 1st Best paper presentation in the national level symposium on scope of renewable energy and its Applications(SORESA 2022).
- Participated in the 6th IET GCC Robotics Challenge.
- 3Rd Annual solar decathlon sponsored by bp Oman held in German University.
- Workshop in Robotics.
- 2020 , participation in Injaz .
- Electricity production methods and auxiliary systems workshop organized by Kahramaa corporation for maintenance and general services.

COURSES

- Master in Artificial Intelligence Engineer:
 - Introduction to AI .
 - Data science with python
 - Machine learning
 - deep learning with keras and TensorFlow
 - AI capstone project
 - python for data science
 - Advanced Deep learning and computer vision
 - Natural Language processing .
 - Industry Master class- Artificial Intelligence
- Introduction to IOT by DOTNEXT Program .
- Introduction to entrepreneurship
- Leadership & RE-Purposing
- Innovation in Oman 2040 vision
- Digital innovation opportunities within government
- National & international supply chain
- Fintech innovation & opportunities
- 3D Technologies & Fabrication
- Disruptive Technologies

